

DRAWING NO.

REVISION

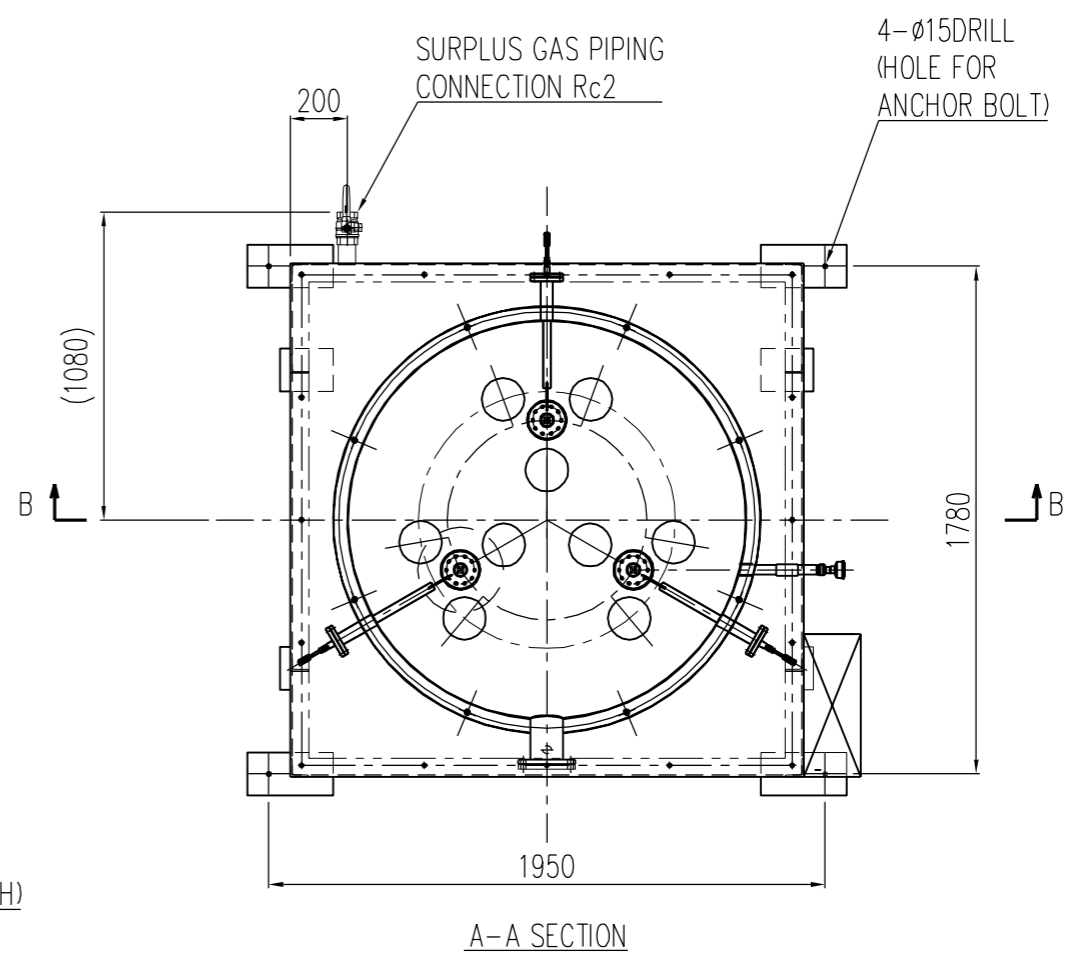
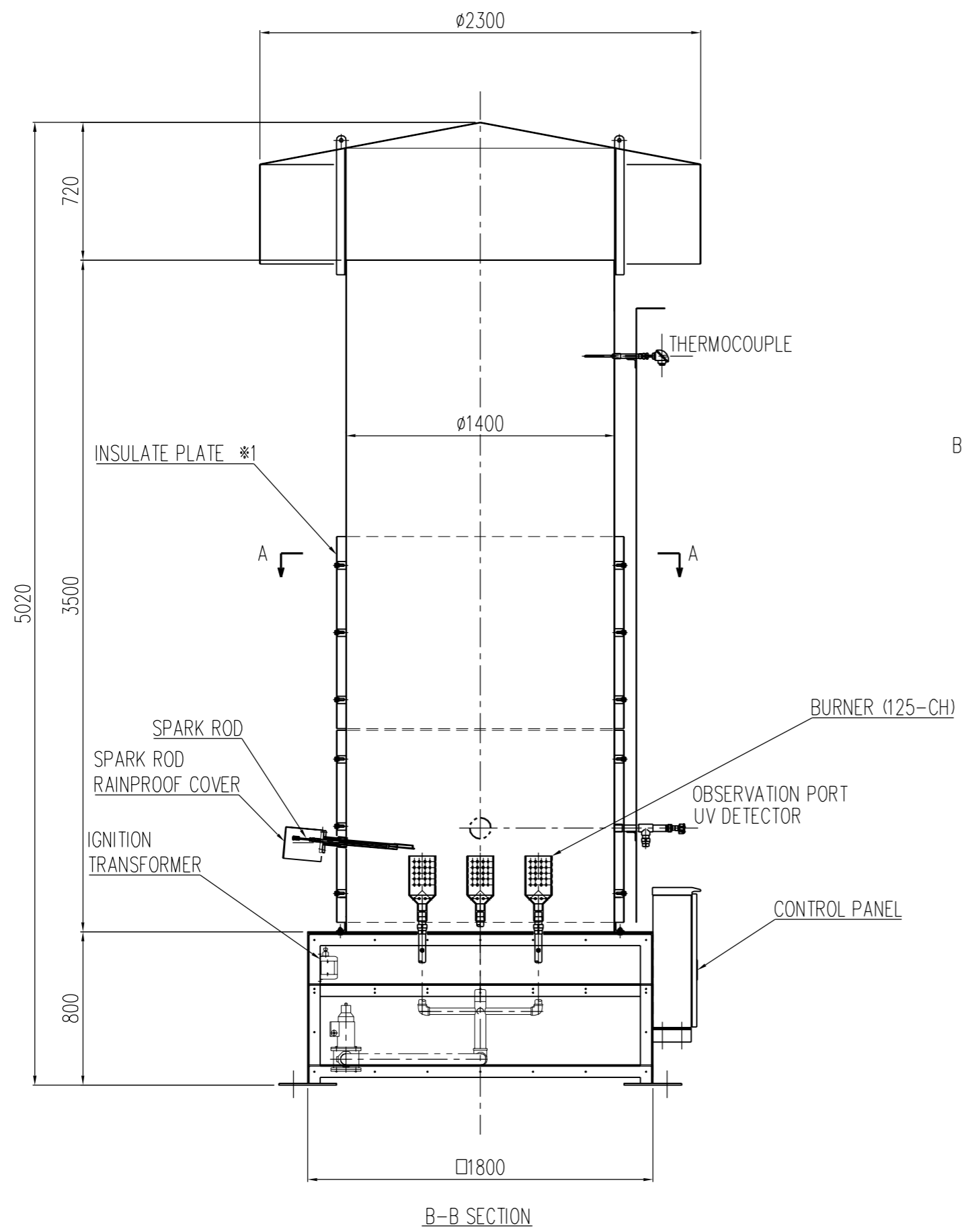

*1 OPTION : ADDITIONAL PLATE

NO.	DESCRIPTION	MATL.	QUANT.	REMARKS
TITLE	SURPLUS GAS COMBUSTION SYSTEM		USER	
	type - 3		CUSTOMER	
	EXTERNAL DIMENSION		DATE	**.***.2020
			SCALE	1:25
DWG. No.			THIRD ANGLE PROJECTION	
	GENERAL MANAGER	MANAGER	CHECKED	DESIGNED
		T.Y	T.Y	C.O